

I P D

INTELLIGENT
PROSTHETIC
DENTISTRY

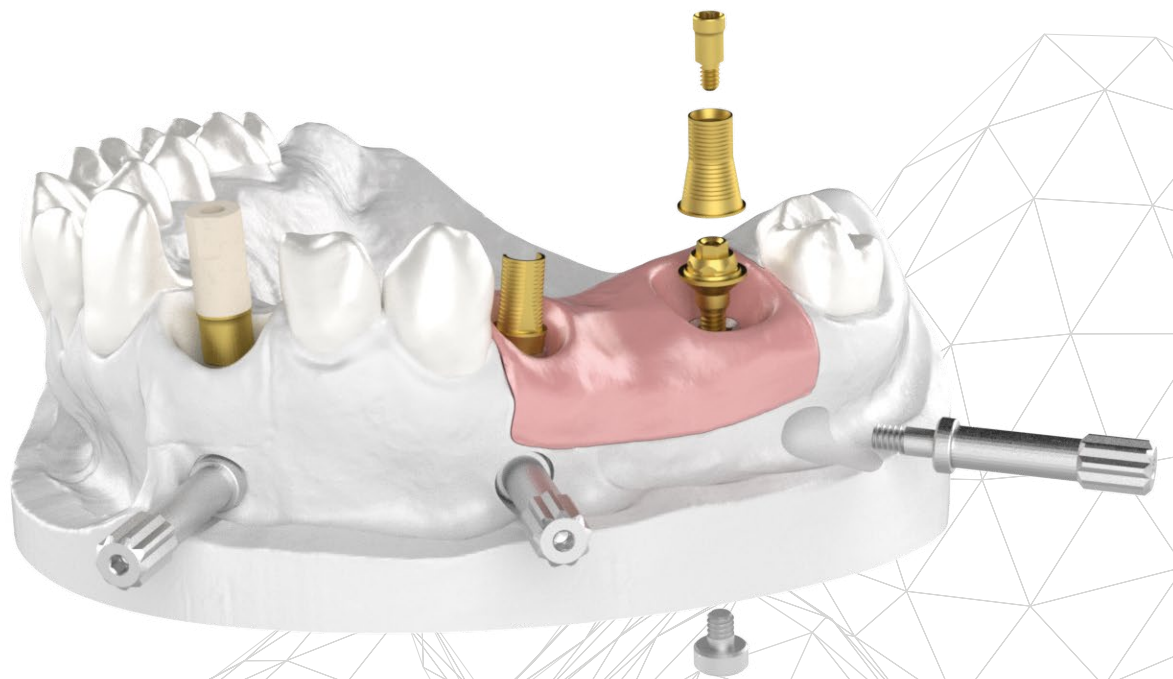

Be **I**nnovative
Be **P**recise
Be **D**igital

Be **ipd**

Index

Be Innovative

Custom Ti-Base System	03
PSD System	04
Multi-unit System	04
TPA System	05
Cerec® Ti-Base	05

Be Precise

Scan Abutment	06
Scan Transfer	07
Digital Analog	07

Be Digital

CAD Solutions	08
ModelPro	09
Stump Die 3D	09

Compatibilities

10

Be Innovative

Custom Interface Ti-Base System

Flexibility made Ti-Base

The most flexible and versatile Ti-Base on the market

Choosing a suitable Ti-Base for each clinical case and restoration is essential for a long term success

Custom Interface Ti-Base system Get to know its innovative design

- + Asymmetrical **tri-lobe engaging** design.
- + **Easier to mill** geometry.
- + **Helical spiral** grooves for improved retention.
- + **Larger surface area for the prosthetic restoration** to avoid insufficient thickness depending on the materials used.
- + **Three different Ti-Base platforms:** Narrow, Regular, and Wide. The emergence profile will accordingly grow from implant to prosthetic restoration.
- + **Adjustable height:** With 8 mm as standard for the engaging versions and 6.5 mm for non-engaging.
- + **The recess for the Angled Screw Channel (ASC) can be adjusted** for both engaging and non-engaging. Check availability according to implant system.
- + **CAD-CAM** libraries are available for all possible variations.
- + Different **gingival heights** for up to 3.5 mm.
- + **Cutting guides** with fixing screw facilitate cutting and **trimming**

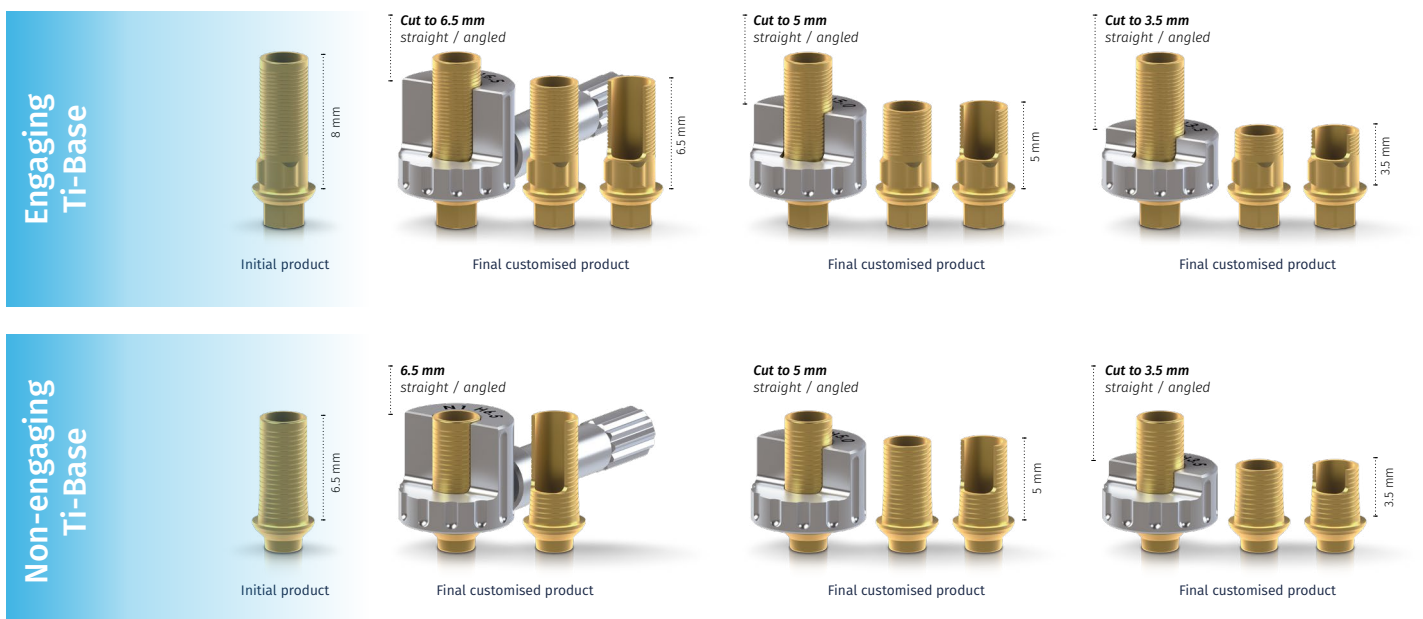
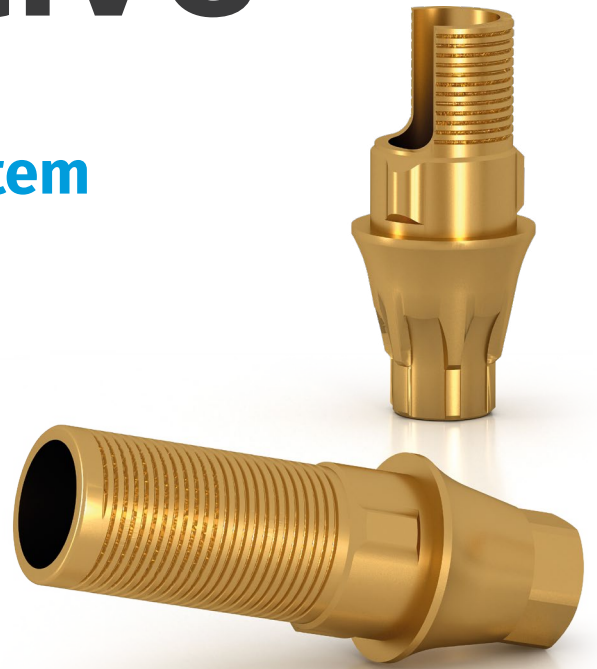

PSD System

Locator® Compatible

Small improvements make big differences

Fully compatible with the Locator® system will bring you the chance to improve without changing.

The two PSD available retention set will be enabling to save up to 40° divergence levels between implants. Each set will be including the relevant three retention level sleeves. The reduced coronal geometry of the PSD anchor reduces the necessary vertical dimension improving not only aesthetics but prosthetic resistance.

TiN coating

The TiN coating improves periodontal aesthetics whilst reducing friction level getting into less wear for abutment and retention.

First digitalized overdenture system

IPD releases a one-of-kind solution enabling to digitalize PSD attachments. Nevertheless this item has also been designed to maximise the benefit by supporting additional features such as impression coping or carrier.

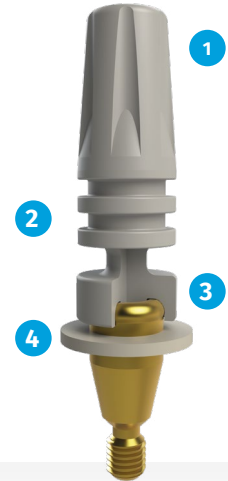
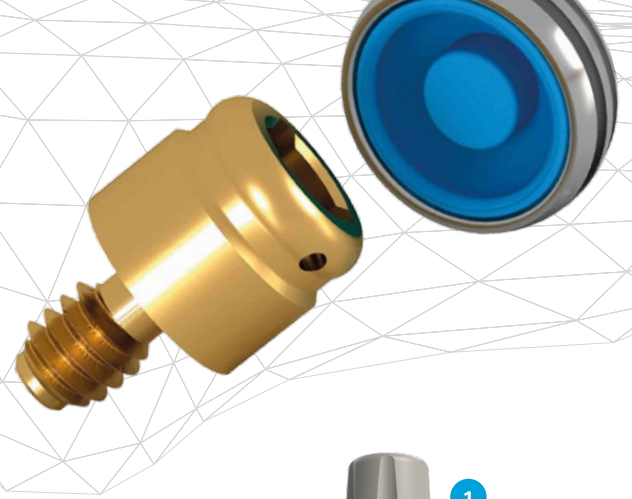

- 1 Carrier
- 2 Impression coping
- 3 Scan Abutment
- 4 Dike

Carrier

Thanks to its ergonomic design, this accessory allows to easily handle as well as aiding clinicians at chairside.



Impression Coping

Cutting the carrier just above the grooved shape will allow it to be used as an impression cap whereas it will also be possible to splint them if necessary.



Scan Body

By simply cutting on the blue line customer will get through a PSD Scan body supported by its relevant CAD libraries and even the very first 3D analogue for overdenture attachments. As always it is available for the major CAD systems in the market.



Multi-unit System

Aesthetic and precision

Exceeding expectations

The Multi-unit system has evolved to offer better features and new functionalities.

Find out everything that the Multi-unit system can do to improve your workflow.

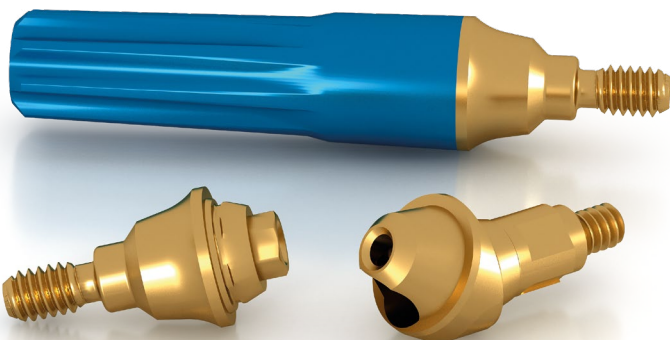

Multi-unit System

Straight Multi-unit for one-piece abutments

We modify every Multi-unit to incorporate an engaging design that is adaptable to one-piece abutments. Thanks to this new functionality, all straight Multi-units can be used to solve cases which require the positioning of a single crown restoration. The corresponding prosthetic components fulfil this new functionality in order to work either analogously or digitally. This morphology change does not affect the usual Multi-unit procedures.

TiN coating

The Multi-unit abutments are coated with Titanium Nitride (TiN). This coating enhances the aesthetics of the abutment with a gold colour. This visually improves cases where patients have exposure of the trans mucosal abutment, and the case is compromised. It also provides antibacterial properties that prevent the adhesion of micro-particles that could result in soft tissue inflammation.

Carrier

Every order for a straight or angled Multi-unit comes with a carrier free of charge.

TPA System

The strength of TPA

Higher performance on torque transmission

TPA is our unique system developed to properly support all Angled Screw Channel Solutions (ASC). Its penta-lobe head design enables to solve compromised aesthetics clinical cases due to non-convenient implant placements.

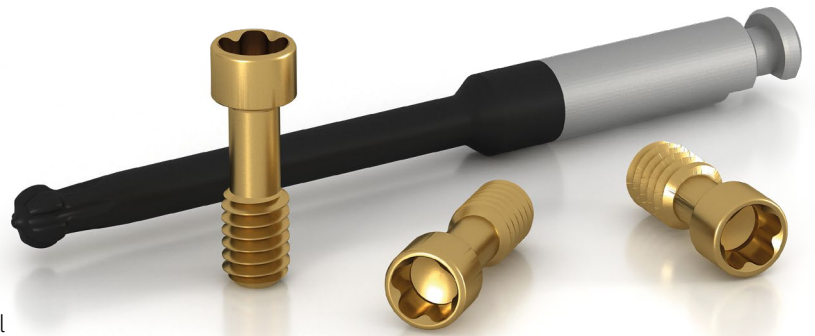

TPA Screw

The penta-lobe head

Socketed offers a more stable grip guaranteeing the full torque transmission as well as saving from suffering deformations.

TPA Screw tip

The penta-lobe elliptical tip

Offers the most appropriate design to ensure an efficient transmission of the torque value at all angles. The unique design has shown to increase fracture resistance up to 9.7%.

DLC coating improves tip hardness up to 2,500 Vickers whilst offering a lower friction coefficient saving from jamming. Available into three different total lengths to support all clinical cases: 18, 25 and 32 mm.

Compatible with all IPD

Angled Screw Channel solutions

TPA system will be in force whether running into a direct to implant or on top of Ti-Base framework as well as IPD's CoCr bases on its standard CAD supported versions.

Cerec® Ti-Base ^{NEW}

IPD presents InLab® and Sirona® Cerec® compatible Ti-Base abutments.

- + Fully compatible with Sirona® digital workflow and its CAD libraries.
- + With the Cerec® Ti- Base we are introducing new technical innovations.
- + TiN coating provides an excellent aesthetic finish with the additional benefit of antibacterial surface properties.
- + Helical grooves on the Ti-Base provide for an improved level of mechanical retention.
- + Different gingival heights to allow for different emergence profiles.
- + Wide range of implant systems*.

*Estimated availability second half 2023



Be Precise

Scan Abutment

Accuracy, fit and reliability

One system, all solutions

Revolutionary high-precision Scan Abutment giving access to a fully integrated digital workflow.

A Scan Abutment suitable for both intraoral and desktop scanning devices enabling to perform implant level frameworks as well as giving access to our Custom Interface Ti-Base System or the one-of-a-kind high precision 3D printed models.

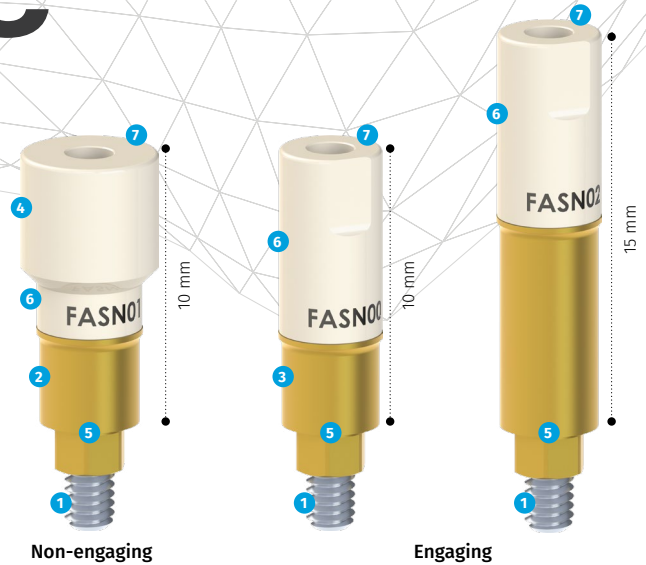

Scan Abutment

- + Compatible with **intraoral systems** (clinical) and with **desktop systems** (laboratory).
- + Also compatible with the **Renishaw® probe system**.
- + **It includes a captive screw** to prevent loss and make it easier to mount.
- + **The TiN coating** offers antibacterial properties to protect the gingiva.
- + **The Titanium connection** ensures a long-lasting connection and enables the use of Rx.
- + The top section is made of **PEEK**, a polymer that favours implant reading and location.
- + **Maximum Z-precision**, as it rests on the sagittal plane of the implant or analog.
- + **A tolerance of ± 5 microns** throughout the entire manufacturing process.
- + Reference engraved by **laser etching**.
- + **2 heights for engaging**: 10 mm for most cases, and 15 mm for situations involving a very deep implant.

- 1 Captive screw
- 2 TiN coating
- 3 Titanium connection
- 4 Head PEEK
- 5 Maximum Z-precision
- 6 Reference laser etched
- 7 2 heights for engaging versions

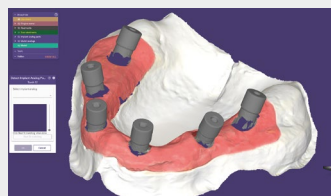

NOK. Best fit with wrong tolerance

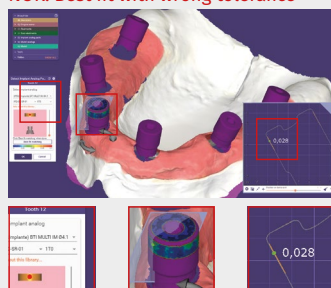

OK. Best fit with optimal tolerance



Optimal Best-fit

CAD Alignment

Digital accuracy means being able to align two STL meshes as accurately as possible.

IPD is the only manufacturer that has taken into account the oversizing that occurs when scanning and has developed a universal tool to help solve it.

By providing the customer with an assortment of 7 different STL files for each IPD scan bodies enables the possibility to improve CAD alignment regardless of the scanning device used.

Scan Transfer ^{NEW}

The dedicated abutment for a precise IO-based workflow for full arch treatments. Scan Transfer is the first abutment offering clinicians a reliable protocol to precisely restore the most demanding clinical cases. Its design and geometry allow them to be splinted creating a guide for the scanning accuracy by reducing scan distortion and increasing consistency and repeatability. Thanks to Scan Transfer the most demanding clinical cases can be fully restored with an IO scanning device achieving the desired passive fit.

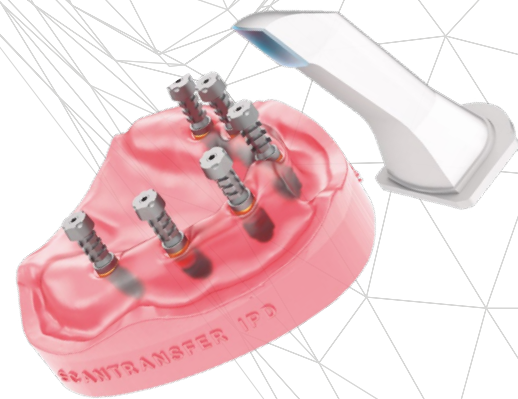

Technical Specifications

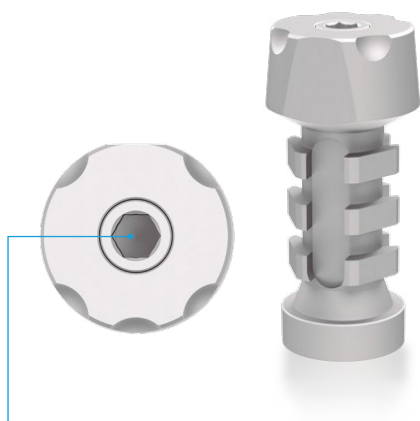

TECHNICAL SPECIFICATIONS

- + Tapered design for easy axial scanning
- + 5 µm
- + Asymmetrical orientation cut-outs
- + Maximized scanning area
- + Retentive body that facilitates splinting

SPECIFIC LIBRARIES

- + Direct to implant library
- + Direct to implant library with ASC
- + Ti-Base level library
- + Ti-Base level library with ASC
- + Library for straight temporary abutment
- + Digital 3D Model

Verification Screw

Confirmation that the Scan Transfer is positioned correctly when the screw is flush with the top of the abutment.

Compatible with:



Digital Analog

The most stable and precise

3D printing accuracy and reliability

The innovative design of the Digital Analog, with two fixation screws, ensures the exact positioning of the digital analog in a 3D printed model. The two fixation screws ensure that the Analog is in the correct position, with one located laterally and the other positioned at the bottom of the 3D printed model. The lateral screw also allows the use of articulator without loss of the bite register.



Validation master

IPD provides a master STL file to allow final customer checking their printing device resolution. At the same time, a pretend 3D analog will be provided free of charge to allow testing the adjustment on the printed calibration master in a convenient, simple and fast way. Once acknowledge this value customer will have access to a customised CAD library with optimised parameter. There are existing up to 11 different CAD library files to ensure making it suitable to efficiently work with any 3D printing system.

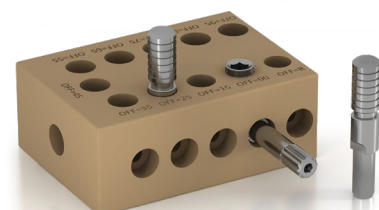

Be Digital

CAD Solutions

For all the leading CAD software systems on the market.

Our aim is to simplify and improve the most your digital workflow by providing accurate solutions to your everyday digital challenges. We have developed and tested a full system to guarantee an accurate fully digital flow.

Scan Abutments Extra/Intra-Oral system is the definitive and most integrated solution on the market, allowing you to work with any type of CAD library, Ti-Bases, Direct to Implant (milled connection and sinter-milled connection), Digital Analog (3D printed model), Scan Transfer and more.



Ti-Base level full contour



Ti-Base level framework

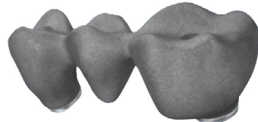

Implant level sinter-milled connection

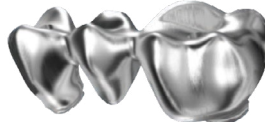

Implant level milled connection



Digital analog / 3D printed model

Implant Level Libraries

Library file that allows to freely design any framework type at implant level, with both straight and angled screw channel.



Ti-Base Level Libraries

Library file allowing the design of any type of prosthetic solution on top of the exclusive IPD Custom Ti-Base to produce cemented-screw retained restorations. It's a versatile solution for intended use with aesthetic raw materials offering the most appropriate final result for each clinical case thanks to its flexibility as well as all supported options. For example, the two adjustment tolerances: A tighter and a looser one to support from ceramic to sintered CoCr or PMMA frameworks for example.



3D digital model

Through intraoral or Desktop scanning will allow to create high precision 3D models simplifying and facilitating the whole clinical and lab protocol. The full system has been developed to provide a stable, accurate and cost-effective solution.



ModelPro

Powered By IPD Dental Group

ModelPro is a dedicated CAD software to the design of 3D models, among many other options, offering in a single software the features of the main dental and mesh editing software's.

Cloud-based, it is the first CAD software that can run on both Windows and Mac OS®. The lack of a dongle allows unlimited installations, and the cloud-based environment offers free access via relevant credentials from anywhere, anytime. Exclusive for IPD customers it offers a top CAD software for designing 3D models completely free of charge.

Model Pro is also supporting unique features such as "Scan Abutment Replace", which allows switching to an IPD workflow from a third-party scan, or the exclusive "Stump Die 3D" system



*ModelPro is an IPD software submitted to medical devices compliance rules. Check market availability with your IPD official dealer.

- + 3D Model
- + Automatic detection margin prep from CAD
- + Mesh edit, reparation and restoration
- + Scan Abutment alignment
- + Detachable dies
- + Stump Die 3D
- + 3D articulator
- + Digital analog
- + Detachable soft tissue
- + Scan Abutment Replace

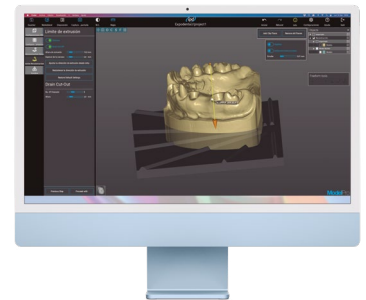
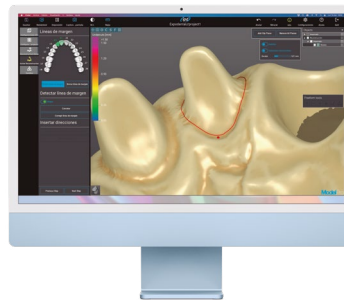

Stump Die 3D NEW

Our software is designed to extend beyond dental implants and provide you with solutions across a range of digital restorative applications.

We understand that producing accurate, detachable dies in 3D printed models can be a challenge. We have developed a system which prevents any mobility and rotation of the detachable die. This solution ensures accurate positioning of the die in relation to the contact points of the adjacent teeth.

IPD's unique solution gives you the tools to ensure predictability and consistency with the removable dies in your 3D printed models.

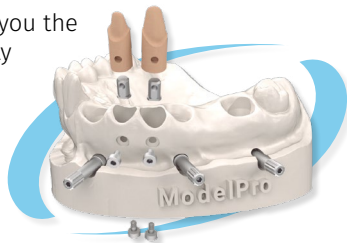

Technical Specifications

- Double fixation at 90° which ensures the correct position of the die in the model.
- Screws with quick thread for easy handling.
- Unidirectional plane for positioning according to the model design.
- Extended width at the base of the insert to check for proper seating.
- Reduced size to enable its use in all types of dies.

Printer calibration



Screw attachment to the insert for easy manipulation of the test fixture



The Stump Die 3D master file will allow to check printer resolution enabling to choose the relevant OFF value into ModelPro aiding to achieve a proper fitting.

*ModelPro and Stump 3D subject to territorial availability. Consult us for disponibility.

Compatibilities

- **AB Serie** MUTI-UNIT [ø4.8]
- **NOBEL BIO CARE®**
 - AA Serie BRANEMARK SYSTEM® [ø3.5 / ø4.1 / ø5.1]
 - AC Serie NOBEL REPLACE® SELECT [ø3.5 / ø4.3 / ø5]
 - AD Serie NOBEL ACTIVE® [ø3.0 / ø3.5 / ø4.3]
- **BIOMET® 3i®**
 - BA Serie OSSEOTITE® [ø3.4 / ø4.1 / ø5]
 - BB Serie CERTAIN® [ø3.4 / ø4.1 / ø5]
- **KLOCKNER®**
 - CA Serie SK2-NK2 [ø4.2]
 - CB Serie ESSENTIAL CONE® [ø4.5]
 - CC Serie KL™ [ø3.5 / ø4.1 / ø5.1]
 - CD Serie VEGA® [ø3.5 / ø4.0 / ø4.5]
- **STRAUMANN®**
 - DA Serie TISSUE LEVEL [ø4.8 RN / ø6.5 WN]
 - DB Serie BONE LEVEL [ø3.3 NC / ø4.1 RC]
 - DC Serie BLX® [RB/WB]
- **ASTRA®**
 - EA Serie OSSEOSPEED™ [ø3 / ø3.5-4 / ø4.5-5]
 - EB Serie EVOLUTION® [ø3.6 / ø4.2]
- **ZIMMER®**
 - FA Serie SCREW VENT® [ø3.5 / ø4.5 / ø5.7]
 - FB Serie SWISSPLUS® [ø4.8]
 - FC Serie EZTETIC® [ø3.1]
- **BTI®**
 - GA Serie EXTERNAL [ø3.5 / ø4.1 / ø5.5]
 - GB Serie INTERNAL UNIVERSAL® [Universal® ø4.1 / Wide ø5.5]
 - GC Serie MULTI-IM® [ø4.1]
- **MICRODENT®**
 - HA Serie SYSTEM [ø3.5 / ø4.2 / ø5.1]
 - HB Serie UNIVERSAL™ [ø3.5 / ø4.1 / ø5.1]
- **DENTSPLY®**
 - IA Serie XIVE® FRIADENT® [ø3.4 / ø3.8 / ø4.5]
 - IB Serie ANKYLOS® [C/X]
- **CAMLOG®**
 - JA Serie CAMLOG® [ø3.3 / ø3.8 / ø4.3]
 - JB Serie CONELOG® [ø3.3 / ø3.8 / ø4.3]
- **BIOHORIZONS®**
 - LB Serie TAPERED INTERNAL [ø3 / ø3.5 / ø4.5 / ø5.7]
- **SWEDEN & MARTINA®**
 - MA Serie OUTLINK® [ø3.3 / ø4.1 / ø5]
 - MB Serie PREMIUM™ KOHNO® [ø3.3 / ø3.8 / ø4.25 / ø5]
- **PHIBO®**
 - NA Serie TSH® [S2 / S3-S4 / S5]
- **OSSTEM IMPLANT®**
 - OB Serie TSIII [ø3.5 / ø4.0]
- **BIOTECH® DENTAL**
 - QB Serie KONTACT® [RP]
- **NEODENT®**
 - NEW** RA Serie HELIX® HE [ø3.3 / ø4.1 / ø5.0]
 - RB Serie GRAND MORSE™ GM [GM]
 - NEW** RC Serie GM ABUTMENT [RP]
 - RD Serie GM MICRO ABUTMENT [ø3.5]
- **BEGO® SEMADOS®**
 - SB Serie SC/RS [ø3.25 / ø3.75 / ø4.1 / ø4.5]
- **MIS®**
 - TA Serie SEVEN® [Narrow 3.3 / Standard / Wide]
 - TB Serie C1 / V3® [Standard]
- **DIO®**
 - UB Serie UFII [NP / RP]
- **MEGAGEN®**
 - WA Serie ANYONE® [RP]
 - WB Serie ANYRIDGE® [ø4.0]
- **DENTIUM®**
 - XA Serie IMPLANTIUM® / SUPERLINE™ [RP]
- **MEDENTIS®**
 - YB Serie ICX [RP]
- **GLOBAL D®**
 - 1A Serie IN-KONE® [RP]
- **ANTHOGRYR®**
 - 2A Serie AXIOM® BL [RP]



Get to IPD Downloads site



Download IPD latest full catalog

Some products may not be available in your country. Please contact your official distributor for more details.

IMPLANT PROTESIS DENTAL 2004 SL provides prosthetic solutions with compatible connection for different implant systems. The components manufactured and marketed by IMPLANT PROTESIS DENTAL 2004 SL are fully functional with the aforementioned systems. The mention of the implant system brands or typology is made purely for informative purposes and for proper identification of the appropriate dental implant with which the connection of the components from IMPLANT PROTESIS DENTAL 2004 SL is compatible.

The registered brands in IPD 2004 are the property of IMPLANT PROTESIS DENTAL 2004 SL. The other brands mentioned are the property of their respective owners, and IMPLANT PROTESIS DENTAL 2004 SL has no relationship with either they or the aforementioned brands.

Enjoy the new IPD ONLINE SHOP!

Intuitive and easy to use, is born to become the reference e-commerce for top-edge implant componentry.

Quality, precision, and reliability just a click away.

shop.ipd2004.de/en



Be **I**nnovative
Be **P**recise
Be **D**igital

Be 



Camí del Mig, 71
08302 Mataró (Barcelona)

New facilities 2023
C/ Rosa dels Vents, 9-15
08338 Premià de Dalt (Barcelona)

Phone: (+34) 93 278 84 91
info@ipd2004.com
www.ipd2004.com

